



Outdoor Cabinet AC Air Conditioner

User Manual

1 Product Overview

1.1 Application



Important

- The product is designed for communication or related industrial equipment applications and design of high performance cabinet Outdoor cabinet AC air conditioner, Please use the AC Power. The installation is the significance of the control cabinet (normal work to a closed state) of internal temperature control, To ensure that the cabinet all thermal element can work normally, Play the best performance.
- Any damage caused by any other applications outside of the application object described above, Responsibility is not assumed.



Warning

- Transport: In the process of handling or transport of the product, do protect the product and do not over impact.
- Store: Don't open storage, or stored for a long time at high temperature, high humidity environment (70℃,95%).
- Shutdown: If not using this product for a long time, please turn off the main power



Warning

- This appliance is not intended for use by persons (including children) with reduced physical, sensory or mental capabilities, or lack of experience and knowledge, unless they have been given supervision or instruction concerning use of the appliance by a person responsible for their safety.
- If the power supply cord is damaged, it must be replaced by the manufacturer, or service agency or Safety certification in order to avoid a hazard.
- Don't use the product under the condition of high oil, burning gas, explosive gas, strong corrosively condition area. Otherwise the product warrantee service is not been offered by manufacture.

1.2 Product Features

- Suitable for high temperature
- Self-testing function
- Alarming output to monitoring system
- Easy maintenance
- Remote measuring, remote communication, remote control, which can realize can realize multiple
- automatic protection and comprehensive self-testing function;
- Multiple self-protection design & visible monitoring interface, RS485 communication port (MODBUS-RTU protocol);

1.3 Working Principle

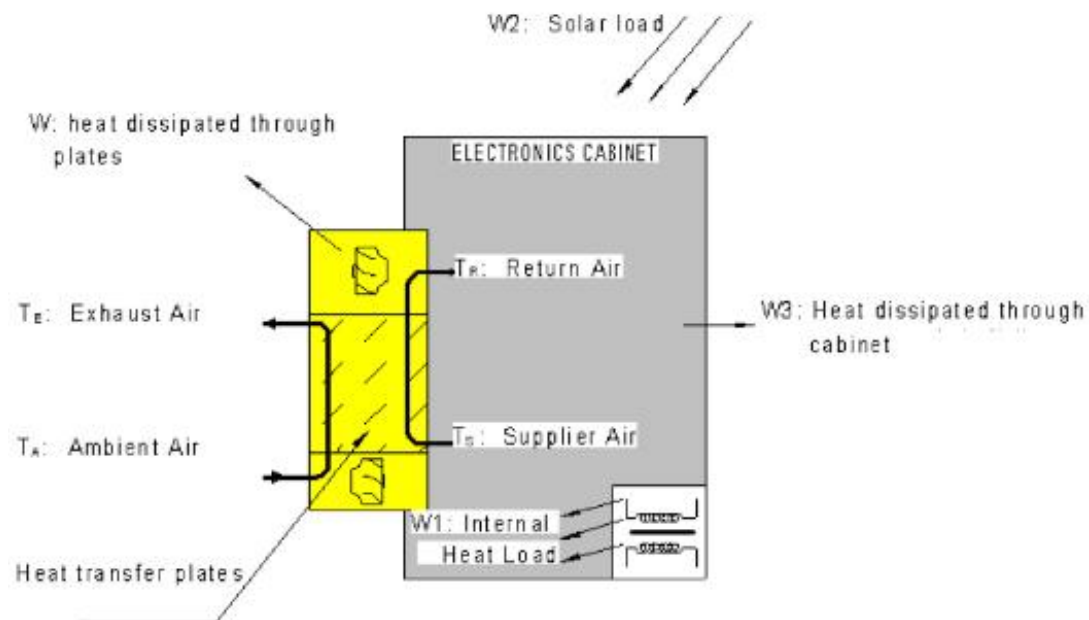

Outdoor cabinet AC air conditioner is mostly used for enclosed area cooling, and it is designed especially for mounting in a cabinet. The unit uses ambient air for temperature regulation so it must have access to ambient. The internal temperature of the enclosure is cooled via effective utilization of the ambient air. An air/air counter-current plate Outdoor cabinet AC air conditioner is used to transfer the heat. Two centrifuge fans, one for the internal circuit and one for the external circuit provide ventilation.

The Outdoor cabinet AC air conditioner module is designed in such a way that the speed of the external circuit fan is controlled according to temperature, based on the pre-set pattern.

1.4 Air Flow Design

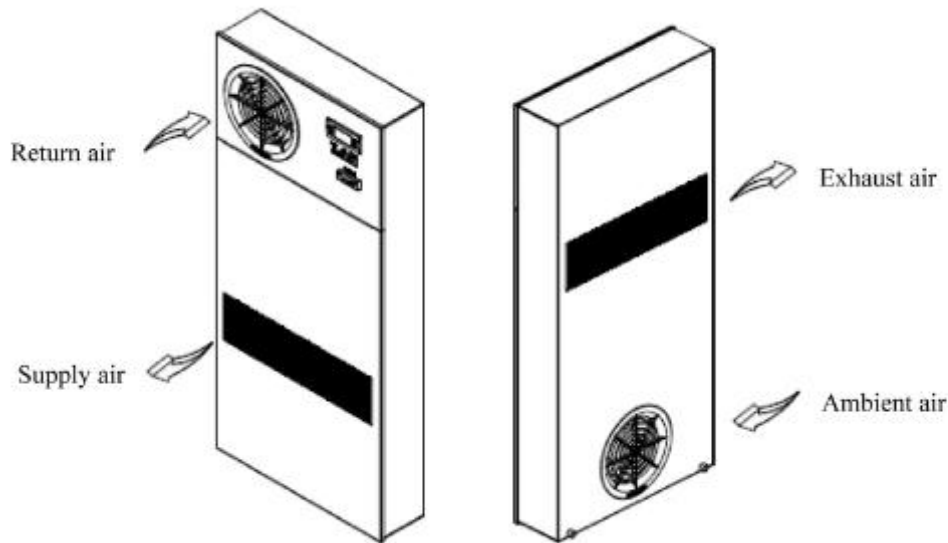

1.5 Operation Logic

Power on the switch, the product will perform a self-test running program firstly. If there is any trouble during self-test, the alarm will be generated, the monitor Display alarm fault code, the system according to the alarm fault code to enter fault handling operation. If there is no trouble during the self-test, system will be normal running automatically.

- Self-test

The self-test procedure is as follows:

First: Detection of return air temperature sensor;

Second: Detection of internal fan;

The Third: Detection of external fan;

The Fourth: Detection of heater (If the machine with heating function) ;

The normal work state of the system includes the state of standby, heat transfer and heating.

- Standby mode

If the return air temperature meets the condition of the Standby mode (not need heating or heat transfer), the Outdoor cabinet AC air conditioner runs into the standby operating state, At this point only the low speed fan inside.

- Heat exchange mode

If the return air temperature meets the condition of the Outdoor cabinet AC air conditioner (cabinet inner temperature is higher than the outer fan start temperature) , the Outdoor cabinet AC air conditioner runs into the heat transfer state, At this point the fan will change speed according to the cabinet inner temperature.

- Heating (Option)

If the return air temperature meets the heating condition (When cabinet inner temperature





is lower than the heater running temperature) , the product will run into heating, with internal fan full speed, external fan stopped.

1.6 Monitor Operation Guide

The interface of the monitor is as follows:



The definitions of the symbols from left to right are as follows:

Indicator	Definition	Light	Flicker
	Point setting	Setting mode	Self-test
	Heat exchange	Heat exchange mode	N/A
	Heat	Heater start	Heater Alarm
	External fan	External fan running mode	External fan Alarm
	Alarm	N/A	Alarm mode

- **Show RPM of internal fan**

Under the return air temperature interface, press“▲” will show the RPM of internal fan, press “M”, will show return air temperature back to main interface.

- **Show RPM of external fan**

Under the return air temperature interface, press“▼” will show the RPM of external fan, press “M”, will show return air temperature back to main interface.

- **Show the current of heater**

Under the return air temperature interface, press“▲” and “▼” will show the current of the Heater (A), press “M “will show return air temperature back to main interface.

- **Show the AC voltage**

Under the return air temperature interface, press “Set” will show the AC voltage with V unit, press “M “,will show return air temperature back to main interface.

- **Controls parameter settings**

Long press "M" key for 5 seconds, enter the parameter setting mode, then display the code of parameters, with "▲▼" key to select the code of parameters, select a code and press "Set" button will display corresponding parameter values of the code, then re-use "▲▼" button can set the parameters, after finished the setting, press "Set "button, back to display states. During the setting mode, Press "M" key to exit the parameter setting mode, in the process of the parameter values setting by pressing "M" button that give up, quit,

but does not change the parameter value. Common settings code as described in the following table:

Code	Specs	Note
F18	External fan stop temperature	
F19	External fan start temp.	
*F23	Heater temperature opening	With heating function selected
*F24	Heater stop temperature return difference	With heating function selected
F28	Communication address	
F29	Temp. of high temperature	
F30	Temp. of low temperature alarm	
F38	External input enable	
F39	External input potions	
F40	High voltage alarm value	
F44	Password	

Note: with " * " setting parameters modification need to enter your password

1.7 Alarm and Fault Management

The monitor displays return air temperature at normally, If it is alarm, temperature and alarm codes are displayed alternately, the alarm code defined as table below.

E01	Int.fan1 defected
E02	****
E03	Ext.fan1 defected
E04	****
E05	Inner temperature senor
E06	****
E07	Heater defected
E08	****
E09	High temperature alarm
E10	Low temperature alarm
E11	High voltage alarm
E12	Low voltage alarm
E13	The external input alarm

1.8 Monitoring

The unit can be monitored by software through RS485 port. Please consult to the manufacture for more information.

2 Installation Guide

2.1 Machine Installation

Please follow the below diagram of installation

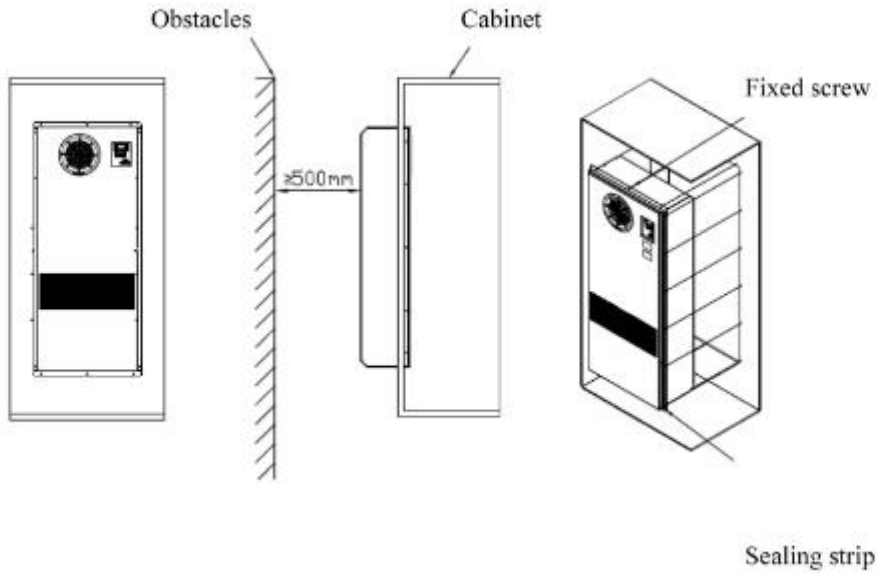

Semi-embedded Mounting

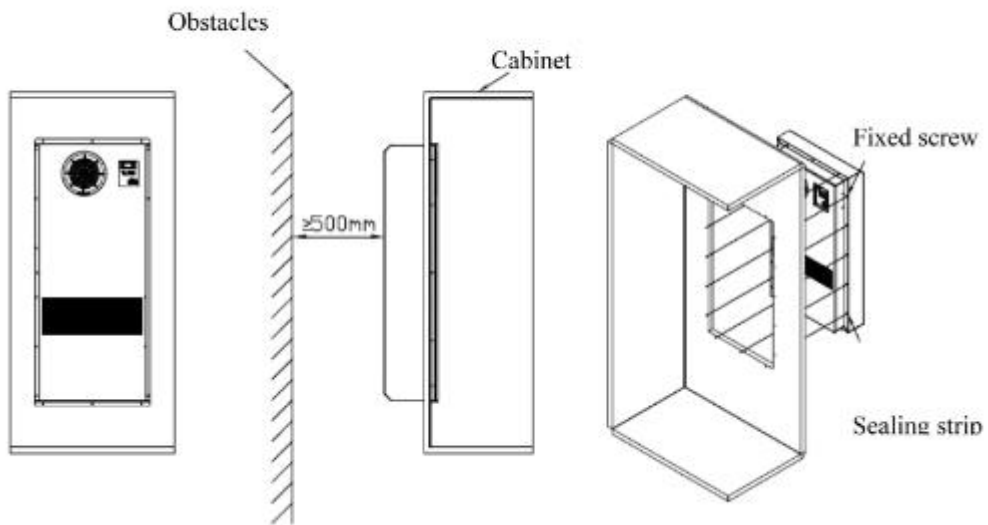

Semi-embedded Mounting

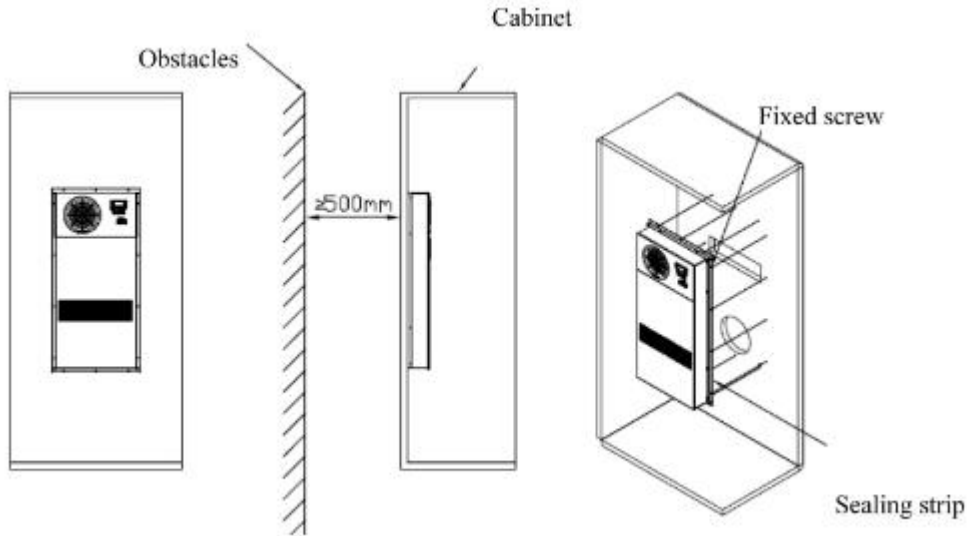

Door Mounting

- Installation steps:

- 1) Removal of packaging box, check the package list and the machine is well.
- 2) Installed the Outdoor cabinet AC air conditioner on the cabinet use screw, as Figure.
- 3) The mechanical part of installation is finished till now. Please double check.



Important

Don't use this unit in high oil, burning gas, explosive gas, strong corrosively condition, the ambient air must be under 55°C, and the humidity not higher than 95%.

2.2 Terminal Instruction

No.	Symbol	Definition	Description
1	TR+	Positive pole of 485 communication	/
2	TR-	Negative pole of 485 communication	/
3	PE	Ground wire power	/
4	L	Live line of AC power	/
5	N	Neutral line of AC power	/
6	NO	Normal open port of dry contract alarm output	Dry contact alarm: Pin 6&7: Normal open Pin 7&8: Normal closed
7	COM	Common port of dry contract alarm output	
8	NC	Normal closed port of dry contract alarm output	
9	I/O	Hydrogen discharging port or external signal input port	Hydrogen discharging or external signal input port both can only choose one: As hydrogen port: Can connect external hydrogen exhaust fan should be less than 1 A As external signal input port: Accept external control signal to control the air conditioner.
10			

Note: The installation of a residual current device (RCD) having a rated residual operating current not exceeding 30mA is advisable.

Pre-operational checks

After Outdoor cabinet AC air conditioner installation and the electrical connection are completed, please check the following checklist:

No.	Check items
1	Ensure the screw is fastening
2	Ensure that there is enough space near the internal and external of the air condition
3	Power line to connect the right polarity. Alarm signal cables are connected correctly
4	Using a multimeter to check the supply voltage, power supply voltage is normal, consistent with the requirements on the nameplate.

Note: the correct power type of the machine sees the nameplate on the machine surface. If the power is not input correctly, the unit will be alarm.



Warning

When the Outdoor cabinet AC air conditioner is running, if there is abnormal noise, vibration, please cut off power immediately and notify the professionals to inspect.

3 Maintenance and Warranty

3.1 Product Maintenance

3.1.1 Prepare Tools

Table3-1 Maintenance Tools

No.	Tools
1	Multimeter
2	Phillips screwdriver
3	Slotted screwdriver

3.1.2 Routine Maintenance

Table3-2 Routine Maintenance

No.	Check items	Check methods	Solution
1	Power line firm	a. Turn off the supply power	If there is a power line looses, You should tie tightly power cable; with a screwdriver to the loose screw
		b. Pulled the power line, watch whether the line is loosening	
		c. Screw the screws on the power cable terminals with a screwdriver, watch whether the screw is loosening	
2	Voltage Stability	Use the multimeter to measure Outdoor cabinet AC air conditioner input voltage to watch whether the voltage is within normal range	If the voltage is not within the normal range, Please turn off the power supply immediately. Power on Outdoor cabinet AC air conditioner until the supply voltage within normal range.
3	Screw firmly	Use scrowdriver to screw the screws and watch whether the screw is loosening	If the screw is loosening, please tighten it.
4	Cooling	Power on the switch and watch whether the self-test is correct.	a. While self-testing, if there is abnormal noise, vibration, please cut off powe immediately and notify the professionals to inspect.
			b. If it is alarm while self-test, please process

- Routine maintenance steps

It is recommended to perform preventive maintenance on the unit twice a year (depends on the location of the site and the nearby surroundings) and the following should be done:

- 1) Listen to the fans while in operation. The sound should be constant and with very little fluctuation otherwise the fans are out of balance and should be replaced.
- 2) Switch all the circuit breakers related to the climate unit off.
- 3) Remove the internal and external fan.
- 4) Clean the blades of both fans using a brush, compressed air and a vacuum cleaner.
- 5) Clean the heat transfer core using a small brush, compressed air and a vacuum cleaner, the air pressure should less than 0.5bar.
- 6) Mount the fans back again.
- 7) Switch the unit ON again. This will activate the internal test program that runs for about 30 seconds, testing the fans at various speeds.
- 8) Finish.

3.1.3 Alarm Code and Handling Method

Table 3-3 Alarm Information

Code Name	Principle	Process Method
Return air temperature sensor alarm	Return air temperature sensor is short circuit or open circuit	Check whether the return air temperature sensor is short circuit or open circuit.
Heater current is too low	Heater current is not within normal range	<ol style="list-style-type: none"> a. Check whether the heater line is loosening b. Heater fault, please contact professional maintenance.
Heater over-current	Compressor current is not within normal range	<ol style="list-style-type: none"> a. Check whether the AC voltage is normal. b. Compressor fault, please contact professional maintenance.
Internal fan alarm	Internal fan current is not within normal range.	Check Whether the internal fan line is loosening.
External fan alarm	External fan current is not within normal range.	Check Whether the external fan line is loosening.

3.1.4 Other fault analysis and treatment

Table 3-4 Other Fault Analysis and Processing

Fault state	Analysis of the reasons	Solutions
Power on the switch, the cabinet temperature is too high but Outdoor cabinet AC air conditioner is not working	a. Power failure or no power	a. Check the power supply and the electric circuit
	b. Machine fault	b. Please contact professional maintenance.
The machine is stopping suddenly ,and the electric system is normal	a. The cabinet temperature greater than or equal to the cooling set temperature.	a. Setting start temperature according to the needs
	b. Other system fault	b. Please contact professional maintenance.

3.2 Service and repair

- Warranty period

The product guarantee period is 12 months from product up-running time or Max. 18 month from product delivery date.

- Warranty coverage

During the warranty period, all belong to the product itself quality problems caused by fault, the company will be free for you to repair; Household repair is required to provide the product label. But by any of the following causes the failure does not belong to our warranty.

- 1) Out of the Warranty period
- 2) Cannot provide the product label (the product label is on the nameplate);
- 3) Because of the abnormal condition or environment, or the instructions specified in the Inappropriate installation, maintenance or operation causes the fault;
- 4) Not caused by equipment failure, caused by user's other equipment or software.
- 5) User changed or disassembles by their self, or maintained by the person without authorization.
- 6) Caused by force major such as fires, earthquakes, floods and other damage to the fault.

Disclaim

The warranty is for the delivered products.

Irresponsible is for any loss that may be caused by equipment failure.

3.3 Reclaim



At the end of the unit working life, the produce must not be disposed of as urban waste; it must be taken to a special local authority differentiated waste collection centre or to a dealer providing this service.